

© 2013 Essentra Components. All rights reserved.
 Registered in England, Company No. 547495.
 Registered Office: Essentra plc
 Langford Locks, Kidlington, Oxford, OX5 1HX

Condition of Sale can be found on our website: essentra.com.

Essentra Components does not warrant that the files will be error free and may create new versions ("Upgrades") at any time, which may correct such errors. Essentra Components has no obligation to notify you of such upgrades. Any upgraded file will be published to the website, when it becomes available.

You are not permitted to load any of the files on to a network server for the purposes of distribution to one or more other computer(s) on that network or to effect such distribution. Essentra Components shall not be liable for any loss or damage whatsoever or however caused, arising directly or indirectly from the use of the files.

UNCONTROLLED COPY

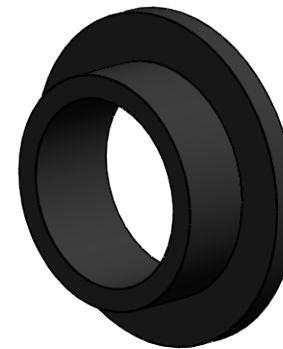
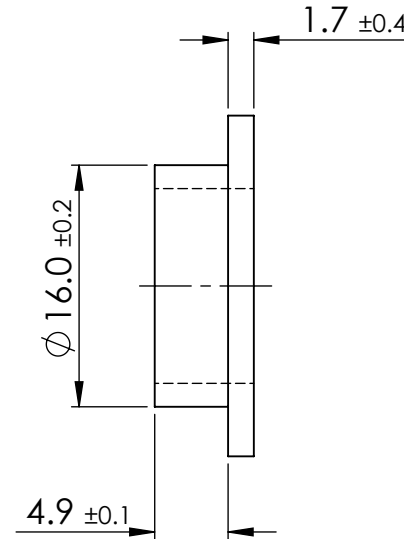
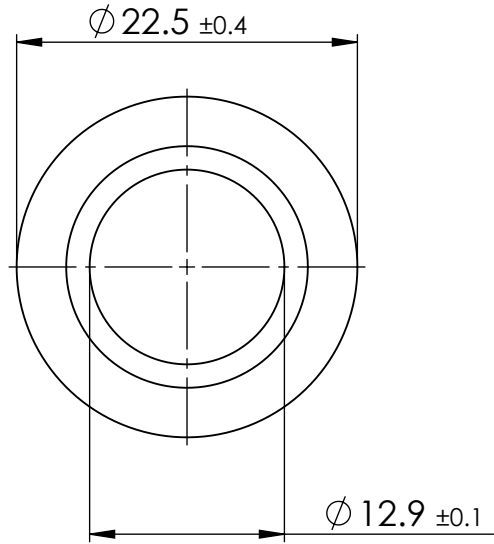

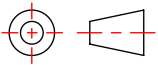
STATUS		APPROVED DRAWING	
UNLESS OTHERWISE STATED			
ALL DIMENSIONS IN mm		DO NOT SCALE	
LINEAR TOLERANCE		THIRD ANGLE PROJECTION	
SIZE	(0) (0.0) (0.00)	 ANGULAR TOLERANCE ±0.5 DEGREES UNSPECIFIED RADII 0.25mm DRAFT ANGLE 0.5 DEGREES DIMENSIONS IN PARENTHESIS () ARE FOR REFERENCE ONLY	
0-10	±0.5 ±0.15 ±0.10		
>10-30	±0.5 ±0.20 ±0.15		
>30-50	±0.5 ±0.30 ±0.20		
>50-100	±0.8 ±0.50 ±0.25		
>100-200	±1.5 ±0.80 ±0.40		
>200-300	±2.0 ±1.20 ±0.80		
>300-500	±3.0 ±2.00 ±1.00		
>500	±5.0 ±3.00 ±1.50	ARE FOR REFERENCE ONLY	
ITEM CODE	20488802	CREATE DATE	20/03/2025
LEGACY CODE	12SWS3039B	MATERIAL	PA66
	-	COLOUR	BLACK
	-	FINISH	-
TITLE:			
SHOULDER WASHER			
-			
DWG. No.	20488802	SCALE	ISSUE
		2:1	1
		SHEET	1 of 2

Condition of Sale can be found on our website: essentra.com.

Essentra Components does not warrant that the files will be error free and may create new versions ("Upgrades") at any time, which may correct such errors. Essentra Components has no obligation to notify you of such upgrades. Any upgraded file will be published to the website, when it becomes available.

You are not permitted to load any of the files on to a network server for the purposes of distribution to one or more other computer(s) on that network or to effect such distribution. Essentra Components shall not be liable for any loss or damage whatsoever or however caused, arising directly or indirectly from the use of the files.

UNCONTROLLED COPY

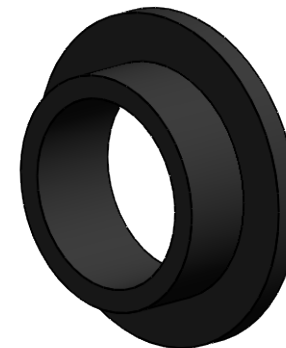
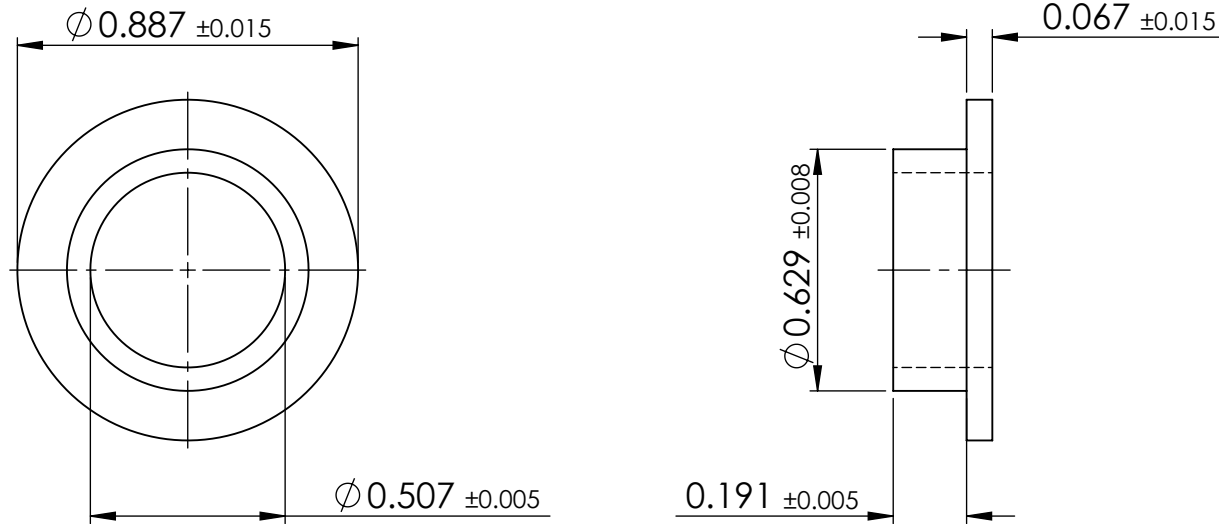

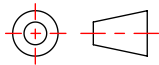
STATUS		APPROVED DRAWING	
UNLESS OTHERWISE STATED			
ALL DIMENSIONS IN inches		DO NOT SCALE	
LINEAR TOLERANCE		THIRD ANGLE PROJECTION	
SIZE	(0.00) (0.000) (0.0000)	 ANGULAR TOLERANCE ± 0.5 DEGREES UNSPECIFIED RADII 0.25mm DRAFT ANGLE 0.5 DEGREES DIMENSIONS IN PARENTHESIS () ARE FOR REFERENCE ONLY	
0 - 0.394	± 0.020 ± 0.006 ± 0.004		
>0.394 - 1.181	± 0.020 ± 0.008 ± 0.006		
>1.181 - 1.969	± 0.020 ± 0.012 ± 0.008		
>1.969 - 3.937	± 0.031 ± 0.020 ± 0.010		
>3.937 - 7.874	± 0.059 ± 0.031 ± 0.016		
>7.874 - 11.811	± 0.079 ± 0.047 ± 0.031		
>11.811 - 19.685	± 0.118 ± 0.079 ± 0.039		
>19.685	± 0.197 ± 0.118 ± 0.059		
ITEM CODE	20488802	20/03/2025	CREATE DATE
LEGACY CODE	12SWS3039B	PA66	MATERIAL
-	-	BLACK	COLOUR
-	-	-	FINISH
TITLE: SHOULDER WASHER -			
DWG. No.	20488802	SCALE 2:1	ISSUE 1
		SHEET 2 of 2	